

Canopy
Crystal 60 cm
Black



EAN 5414425221370

Energy label

▪ Energy Efficiency class (EEIhood)	B
▪ Annual Energy Consumption (kWh/year) (AEChood)	54,7
▪ Fluid Dynamic Efficiency class (FDEhood)	A
▪ Lighting Efficiency class (LEhood)	A
▪ Grease Filtering Efficiency class (GFEhood)	D

Functions & features

▪ Motor	Integrated
▪ Sound absorber	Integrated
▪ Recirculation	Optional
▪ InTouch function	Standard
▪ Auto stop	▪
▪ Delayed switch off (minutes)	10/30
▪ Grease filter	26050020
▪ Number of grease filters	1
▪ Grease filter cleaning indication	▪
▪ Recirculation filter cleaning indication	▪
▪ Control method	Push buttons
▪ Number of speeds	4
▪ Automatic Power revert (minutes)	6

Dimensions

▪ Product dimensions (WxDxH) (mm)	533 x 313 x 308
▪ Width flange (mm)	14
▪ Dimensions cut-out opening (WxD) (mm)	510 x 290
▪ Min dimensions cabinet (WxDxH) (mm)	x 600 x
▪ Advised mounting height induction hobs (Hmin-Hmax) (mm)	650 - 750
▪ Advised mounting height gas hobs (Hmin-Hmax) (mm)	650 - 750
▪ Advised mounting height ceramic hobs (Hmin-Hmax) (mm)	600 - 750
▪ Diameter outlet (mm)	150
▪ Position exhaust	Top

Lighting

▪ Functional lighting type	Led strip
▪ Functional light dimmable	▪
▪ Soft-ON/OFF	-
▪ Number of functional lights	2
▪ Total energy consumption functional light (W)	7
▪ Color functional light (K)	3000

Airflow and noise level

▪ Free airflow (m ³ /h)	700
------------------------------------	-----

Airflow and noise level

- Airflow (m³/h) measured according to EN 61591
- Sound regulation according to EN 60704-2-13
- Airflow duct out speed 1 (m³/h) / Max pressure duct out speed 1 (Pa) 207 / 443
- Airflow duct out speed 2 (m³/h) / Max pressure duct out speed 2 (Pa) 282 / 491
- Airflow duct out speed 3 (m³/h) / Max pressure duct out speed 3 (Pa) 386 / 525
- Airflow duct out max powerspeed (m³/h) (Qboost) / Max pressure duct out600 / 564
max powerspeed (Pa)
- Sound pressure duct out speed 1 (dB(A)) / Sound power duct out speed 27 / 39
1 (dB(A))
- Sound pressure duct out speed 2 (dB(A)) / Sound power duct out speed 33 / 45
2 (dB(A))
- Sound pressure duct out speed 3 (dB(A)) / Sound power duct out speed 40 / 52
3 (dB(A))
- Sound pressure duct out at max powerspeed (dB(A)) / Sound power duct 50 / 61
out at max powerspeed (dB(A)) (LWAbost)

Technical specifications

- | | |
|---|------|
| ▪ Maximum power (W) | 231 |
| ▪ Voltage cooker hood (V) | 230 |
| ▪ Frequency (Hz) | 50 |
| ▪ Power consumption in stand-by-mode (Ps) (W) | 0,23 |
| ▪ Net weight (kg) | 12,5 |
| ▪ Length power supply cable (m) | 1 |

1

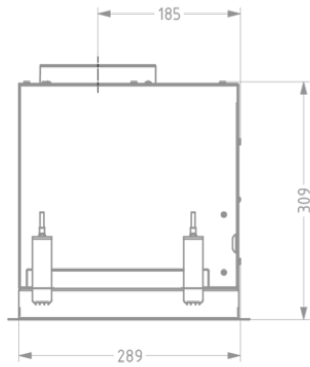

2

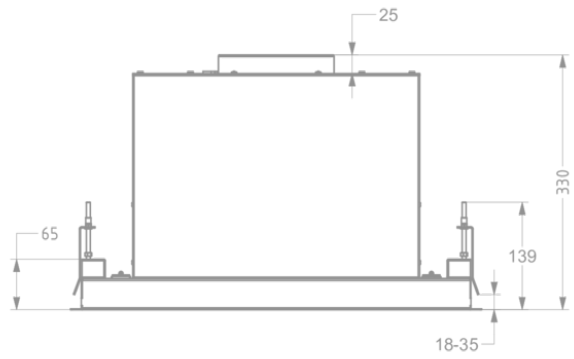

3

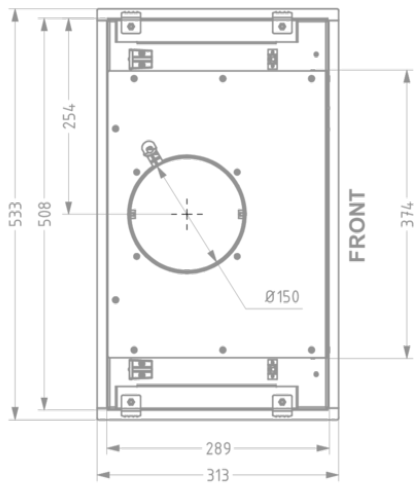

4

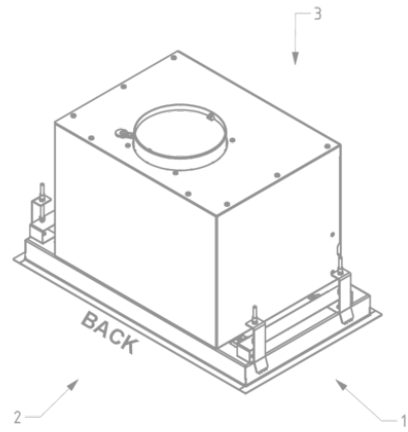

Installation accessories

Additional accessories

- 840029

Remote control

Accessories

Recirculation kit



26050400

Recirculation set Crystal

Control kit



990030

Control kit for external lighting or valve

Efficiency Curve

